

USER MANUAL

uFlamer Gasbar

V1.0
2026/01/08

SHOWVEN®



SHOWVEN Technologies Co., Ltd

Thanks for choosing SHOWVEN uFlamer Gasbar, we wish it will bring you lots of exciting moments.

Please read the following user's manual and related product installation guide carefully before operating this system.

▲ Safety Instructions

1. Safety icons explanation

Safety instructions warn of hazards when handling equipment and provide information on how to avoid those hazards. They are classified according to the severity of the hazard and are divided into the following groups. Please do follow all safety instructions in this document!

DANGER: Indicates a hazardous situation that, if not avoided, will result in death or serious injury. (This signal word is limited to the most extreme situations)

WARNING: Indicates a hazardous situation that, if not avoided, could result in serious injury

CAUTION: Indicates a hazardous situation that, if not avoided, could result in minor or moderate injury.

NOTICE: Provide additional or supplementary information.

2. General Safety Instructions

- ∨ Unauthorized repair are prohibited, it may cause serious incident.
- ∨ Make sure power supply in consistent with the rated voltage of the equipment, and the socket must well grounded. Unplug and turn off the machine when not use.
- ∨ Please connect DMX cable before power on uFlamer Gasbar, and ensure that the communication command is disarmed, and the safety switch of device is under test mode.
- ∨ After turning on the device, no person allows to stay in the danger area. Ensure all persons that are part of the show be informed about the safety distance, risks and functions of the device.
- ∨ Always have a CO₂ fire extinguisher and an extinguishing blanket in case of needed.
- ∨ If there be any doubt as to the safety operation of the device in any circumstances, the device should be taken out of service immediately. Be sure the device is in good operating condition before use. If fail to fire correctly, immediately shut down and check it accordingly. Any questions please always contact SHOWVEN (info@showven.cn) for help.
- ∨ Be sure to use high quality aerosol, gas cartridges/bottles, otherwise, it is easily leads to failure or danger. Please keep those consumable bottles away from heat source, sparks, fire or other possibility of ignition. Do not smoke!
- ∨ Before exchanging aerosol, gas cartridges/bottles or after each usage, please first shut off fuel supply, then empty the remaining fuel in the system (pipeline and gas hose) by activating the flamer several times until no flame is being generated.
- ∨ The operator responsible for the control of flame system must always have a clear view of the device, so that he/she can stop the show immediately when there is danger. The main AC power switch should near operator. So that operator can turn off the power of all devices in case of abnormal.
- ∨ The device shall not be altered and applied to other use purpose.

3. Disclaimers:

SHOWVEN technologies Co., Ltd excludes liability for unsafe situations, accidents and damages resulting from:

1. Ignoring warnings or regulations as shown on product manual or this manual.
2. Use for other applications or circumstances other than those indicated herein.

3. Changes to the device, including use of non-original spare parts, lack of maintenance etc.
4. Dismantling device without authorization from SHOWVEN.
5. Use this machine by unqualified or untrained personnel.
6. Improper use of machine.

Warning:

A dry powder fire extinguisher, a carbon dioxide fire extinguisher and a fire blanket must be equipped next to the equipment. Someone must be on duty during operation. In case of fire accident, dry powder fire extinguisher can be used when the fire is large, and a carbon dioxide fire extinguisher can be used when the fire is small.

▲ Technical Specifications

- \ **Model:** uFlamer Gasbar
- \ **Housing Material:** 304 stainless steel
- \ **Dimension:** 505×173×388mm
- \ **Weight:** 16.5kg
- \ **Input:** AC100-240V, 50/60Hz
- \ **Work Power:** 150W
- \ **Usage in Rain:** Yes
- \ **Battery / Standby Time:** 8 * 18650 cells, about 23.5h standby, support 2h40min firing
- \ **Battery Charging:** Through power cable, about 4hrs
- \ **Work Pressure Range:** 0-20Bar
- \ **Ignition:** both ends, Dual, high voltage electron ignition
- \ **Flame Monitoring:** Yes, dual
- \ **Temp. Monitoring:** triple sensor
- \ **Control:** DMX, Wireless with DMX Receiver (5-PIN DMX IN with DC5V power supply)
- \ **DMX:** 3-pin and 5-pin DMX IN / OUT
- \ **E-Stop Interface:** Yes, can be connected in series
- \ **Effect Direction:** Vertical up
- \ **Effect Length:** 500mm
- \ **Flame Height:** 0.1-1.3m (affected by fuel cartridge pressure, temperature etc.)
- \ **Firing Duration:** 0.1s – 60min adjustable
- \ **Fuel:** Propane or Butane
- \ **Cartridge Holder:**
Triple cartridge holder with 3 shut-off valves and 3 non-return valves and a quick coupler for external gas cylinder
- \ **Cartridge Interface:** 7/16-28UNEF
- \ **Micro Filter:** Yes, installed between shut-off and non-return valves
- \ **Tip sensor:** Yes
- \ **Arm Indicator Light:** Yes

Warning:

When using external gas bottle, always be equipped with a pressure reducing valve, and the input pressure can not exceed 20 Bar.

▲ Structure

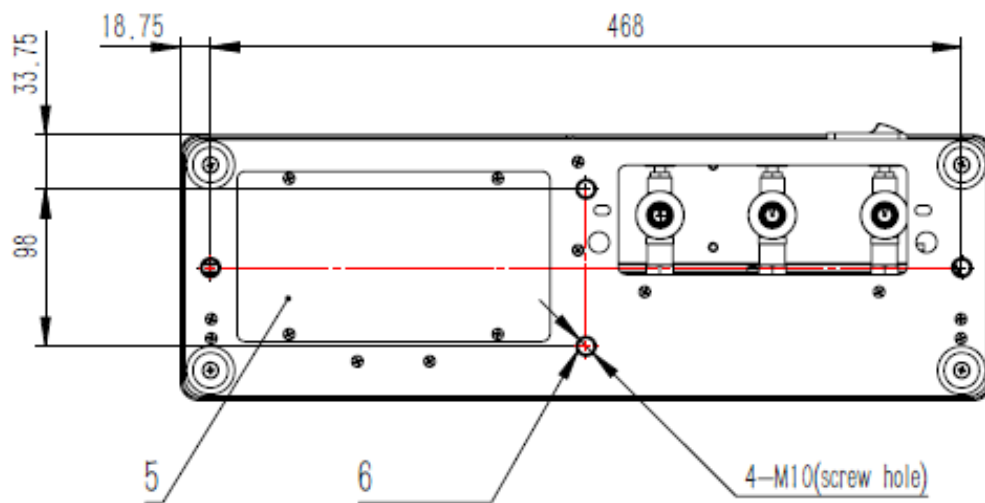
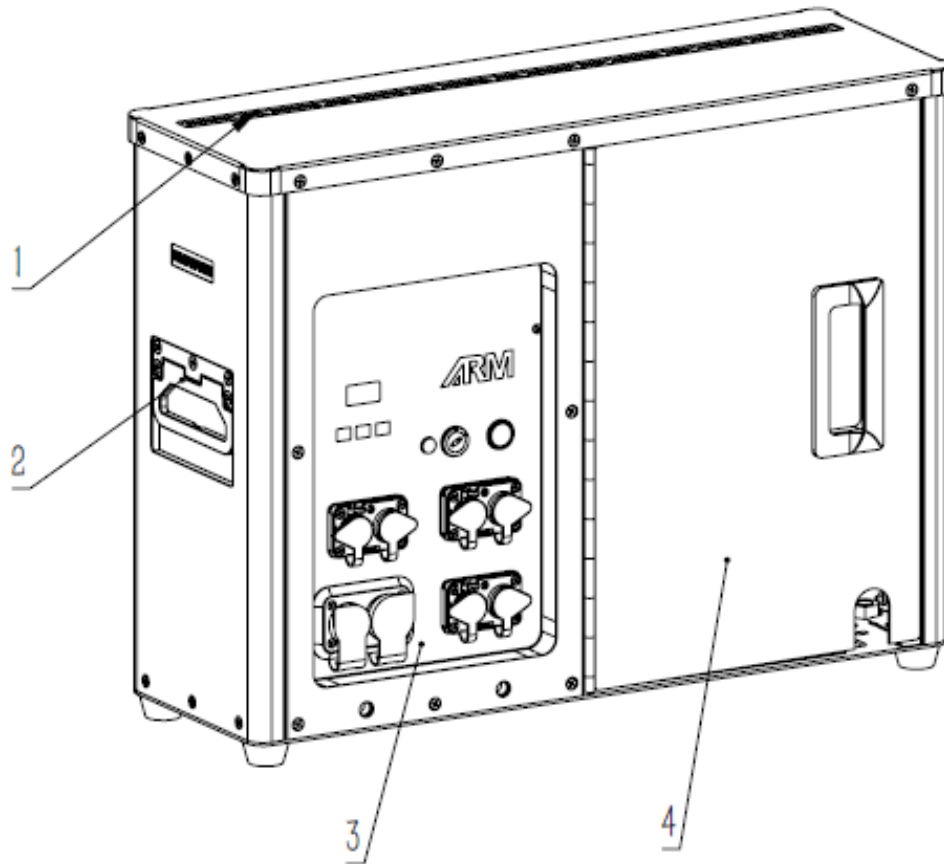

1. Top panel
2. Handle
3. Rear panel
4. Gas cartridge door
5. Battery box
6. M10 scrow hold for clamps

▲ Rear Panel

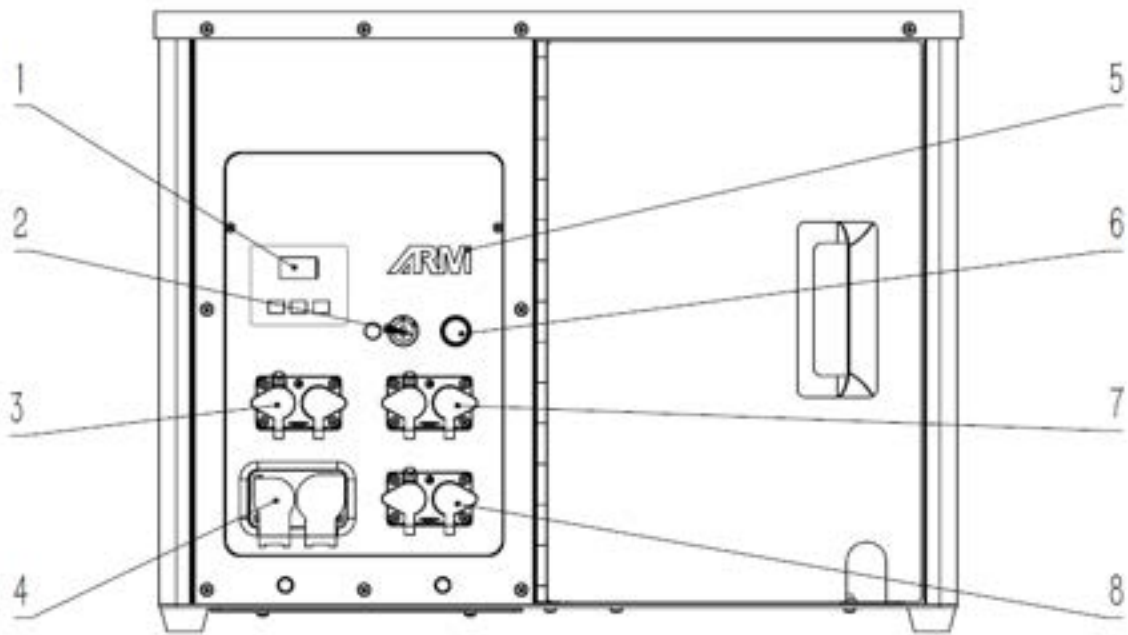

1. LCD Screen
2. Safety Lock Switch
3. 3-pin XLR IN/OUT
4. Power IN / OUT
5. ARM indicator light
6. Power Switch
7. 5-pin XLR IN/OUT (5-PIN XLR IN can charge for wireless DMX pen through pin1 and 4, pin4 with DC5V power supply)
8. E-stop interface

▲ Display and setting

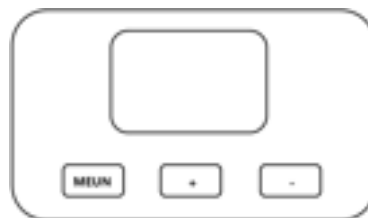

1. Button functions

MENU: Switch to different setting parameters

+: parameters up and save

-: parameters down and save

2. ARM indicator light



Indicator Light	Status	Description	Remark
ARM	OFF	DMX signal input	Operators can enable/disable the ARM indicator light by set the "ARM STATE" in Advanced menu.
	BLINK	DMX armed or wireless ON	
	ON	not in above status (No DMX signal and Wireless OFF)	

3. Welcome Interface

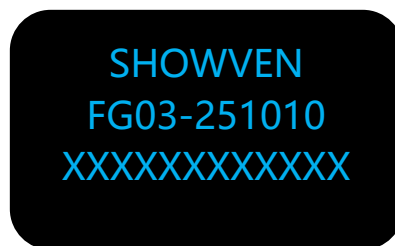

Manufacturer	SHOWVEN
Software Version	FG03-251010
Serial Number	*****

4. Main Interface



Status Bar:

6N / 6P / 6M: DMX mode icon

🔒: it appears when safety switch turn to "USER MODE"

R: Ignition icon, it appears when igniting

🔥: it appears when flame monitor function is ON

🔥: it appears when flame monitor detected a success ignition

⚡: charging

🔋: battery voltage > 16.4V

🔋: battery voltage 15.2v-16.4v

🔋: battery voltage 14.0v-15.2v

🔋: battery voltage 12.7v-14v

🔋: battery voltage < 12.7v

🔋: NO battery

Data Bar:

DMX: DMX address, background color change from black to blue when connected

SAFE: Safety channel address, background color change from black to blue when safety channel activated.

Information Bar:

Alert or error message appears here.

5. Alert Message

Alert Message	Why it appears	How to remove
E0 Test Mode	Safety Switch at TEST MODE	Switch to USER MODE
E0 Factory Mode	Factory mode	Switch to Normal mode
E0 Igniter Dis	Any of the two ignitors disabled in Factory menu	Enable both of the ignitors
E0 Invert	"Invert" set to ON in advanced menu	Set "Invert" to OFF
E0 Jet Valve Dis	Any of the JET 1 to JET 3 valve disabled in Advanced Menu	Enable all three jet valve
E0 Key Lock	"Key Lock" set to "ON" and no operation in 30s	Restart machine can reactivate button

6. Error Message

Error Message	Why it appears	How to remove
E1 Itemp Over	<ol style="list-style-type: none"> 1. Prolonged and continuous firing leads to machine high internal temp. 2. Internal temp. sensor damage 	<ol style="list-style-type: none"> 1. Stop firing, let the machine cool down 2. Check internal temp. sensor
E2 Ptemp Over	<ol style="list-style-type: none"> 1. Prolonged and continuous firing leads to machine high internal temp. 2. Mainboard malfunction 	<ol style="list-style-type: none"> 1. Stop firing, let the machine cool down 2. Check mainboard
E3 Fire Err	<ol style="list-style-type: none"> 1. Ignition failed 2. The flames went out during firing 3. Flame monitor damaged 4. Flame temp. sensor damaged 	<ol style="list-style-type: none"> 1. Restart firing 2. Restart firing 3. Check the flame monitor 4. Check flame temp. sensor
E4 Bat Err	<ol style="list-style-type: none"> 1. Battery voltage error 2. Battery box PCB board malfunction 3. Mainboard malfunction 	<ol style="list-style-type: none"> 1. Check the battery or charging 2. Check battery box PCB board 3. Check the mainboard
E6 Tip Err	<ol style="list-style-type: none"> 1. Machine slant over 45° , it stops running 2. Mainboard malfunction 	<ol style="list-style-type: none"> 1. Tip setting set to OFF, or horizontal install machine. 2. Check the mainboard

E7 Ftemp Over	1. The flame temperature was excessively high due to unknown reasons. 2. Flame temp. sensor damaged	1. Check whether this is something cover the machine 2. Check flame temp. sensor
----------------------	--	---

7. Monitor Interface

Press "-" enter monitor interface, press "MENU" to exit

Menu	Range	Explanation
Item	0-125	Device internal temp. it displays 0 if temp. above 0°C; -40 means temp. sensor disconnected
Ftem	0-1000	Flame temp.
Ptem	0-100	PCB temp.
Fire	0.01-3.30V	Flame detector voltage
User	0-27V	Safety switch voltage
Bat	12-17V	Battery box voltage, charging circuit voltage is displayed when no battery is installed.
DC	0-1V, 10-14V	0-1V: Battery power supply 10-14V: AC supply

8. Main Interface

Press "MENU" enter main interface, press "MENU" switch to different items

Menu	Range	Default	Explanation
Set DMX Address	1~506	1	DMX address setup
DMX Mode Select	6CH-N Mode/ 6CH-P Mode/ 6CH-M Mode	6CH-N Mode	DMX channel mode option
Set Safety Addre	1-512	6	Available only when under 6CH-P mode
RDM XXXXXXXXXXXXXX	ON/OFF	OFF	RDM function ON/OFF

9. Advanced Interface

Press and hold "MENU" for 3s enter advanced interface, press "MENU" to switch interface,

Items	Contents	Default	Description
Drive Test	ON / OFF	OFF	Switch to ON, enter drive test interface
Tip Setting	ON/OFF	ON	Tip sensor ON/OFF setting
Invert	ON/OFF	ON	When turned on, firing sequence will be mirrored.
Flame Monitor	ON/OFF	OFF	Check the firing was success or not

Flame Temp Value	20-60	40	Flame temp. detection threshold value, report error when lower than this temp.
FI Moni Value	0.01V-3.30V	0.32V	Threshold value for a successful firing
FI Moni Fai Num	1-10	2	Consecutive ignition failures setting
Key Sound	ON/OFF	ON	Key sound setting
ARM State	ON/OFF	ON	ARM indicator light ON/OFF setting
LCD Backlight	ON/OFF	ON	ON: Screen long on, blinks when ignition OFF: LCD screen turn off if no operation after a while
Key Lock	ON/OFF	OFF	ON: operation button diable if no operation in 30s, restart machine to activate.
DefaultParamete	ON/OFF	OFF	Reset default parameter settings

10. Test Menu Interface

Press and hold "+" for 3s enter test menu interface, or enter through advanced interface. Press "MENU" to switch to different items.

Items	Contents	Description
ARM Test	ON/OFF	ARM indicator light blinks three times
Jet1 Valve Test	ON/OFF	Jet valve 1 ON and OFF 3 times (test under USER MODE)
Jet2 Valve Test	ON/OFF	Jet valve 2 ON and OFF 3 times (test under USER MODE)
Jet3 Valve Test	ON/OFF	Jet valve 3 ON and OFF 3 times (test under USER MODE)
Igniter1 Test	ON/OFF	Igniter 1 ignite 3 times
Igniter2 Test	ON/OFF	Igniter 2 ignite 3 times

NOTICE: Please disconnect DMX cable before drive test.

▲ DMX CONTROL

uFlamer Gasbar with 3 different channel mode: 6CH-N, 6CH-P and 6CH-M.

6CH-N:

Channel	Function	Value
CH1	-	-
CH2	Small flame firing duration	Firing duration of small flame under small flame and big flame cycle mode, small flame firing duration = DMX Value * 100ms (default duration is 0.7s if no DMX value) It works under small flame and big flame cycle mode
CH3	Firing ON/OFF	0~253: Firing OFF 254~255: Firing ON

CH4	Big flame firing duration	Firing duration of big flame under small flame and big flame cycle mode, big flame firing duration = DMX Value * 100ms (default duration is 0.3s if no DMX value) It works under small flame and big flame cycle mode
CH5	Preset sequence setup	0-2: no preset sequence 3-255: preset sequence DMX value = 2 + Sequence No.*2.55 (ROUND OFF)
CH6	Firing Enable / Disable	0~49 and 201~255: Firing Disable (Emergency STOP) 50~200: Firing Enable

6CH-P:

uFlamer Gasbar occupies 5 functional channels and a separate safety channel, which can be shared with other flame units.

Channel	Function	Value
CH1	-	-
CH2	Small flame firing duration	Firing duration of small flame under small flame and big flame cycle mode, small flame firing duration = DMX Value * 100ms (default duration is 0.7s if no DMX value) It works under small flame and big flame cycle mode
CH3	Firing ON/OFF	0~253: Firing OFF 254~255: Firing ON
CH4	Big flame firing duration	Firing duration of big flame under small flame and big flame cycle mode, big flame firing duration = DMX Value * 100ms (default duration is 0.3s if no DMX value) It works under small flame and big flame cycle mode
CH5	Preset sequence setup	0-2: no preset sequence 3-255: preset sequence DMX value = 2 + Sequence No.*2.55 (ROUND OFF)
CH-S	Safety Channel	0~49 and 201~255: Firing Disable 50~200: Firing Enable

6CH-M:

Channel	Function	Value
CH1	Firing direction	0~85: Firing from left to right 86~170: Firing from right to left 171~255: Firing together
CH2	-	-
CH3	Firing ON/OFF	0~253: Firing OFF 254~255: Firing ON
CH4	-	-
CH5	Flame height	0-128: small flame 129-255: big flame
CH6	Firing Enable / Disable	0~49 and 201~255: Firing Disable (Emergency STOP) 50~200: Firing Enable

▲ Operation

1. Safety distance explanation

Safety distance for uFlamer II divided into two parts safety radius around machine (a) and safety distance at firing direction (b). No person and flammable materials are allowed to stay inside the safety isolation zone when flamer was armed.

a1 and **a2**: The safety radius around machine, depends on the firing height.

b: For safety distance at firing direction.

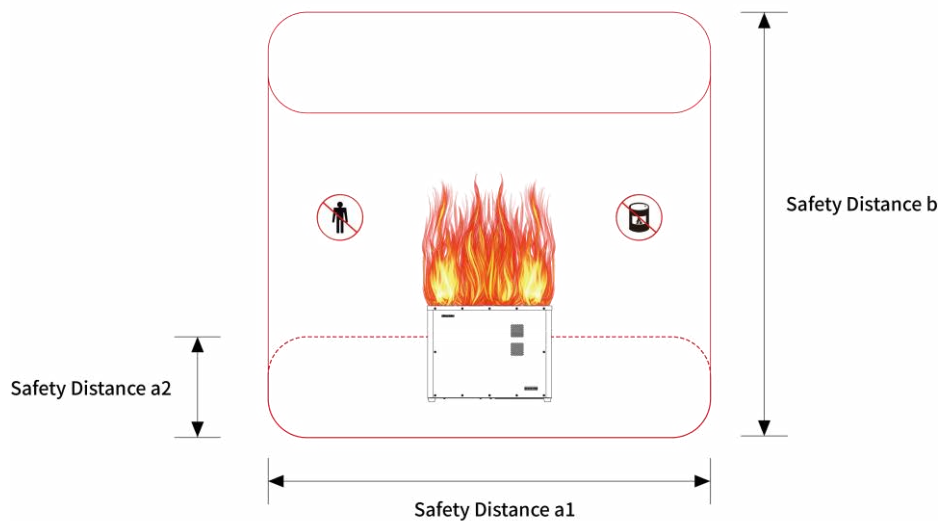

Temp.	-10~10°C	10~25°C	25~40°C
Flame height (m)	0.1~0.5	0.2~0.7	0.3~0.9
a1 (m)	4.5	5	5
a2 (m)	4	4	4
b (m)	4.5	4.5	4.5

NOTICE: The flame height here is the test result by firing with 3 pcs 450g cartridges; 3 450g cartridges support a firing of around 40min. (due to the decrease on temp. caused by fuel vaporization, the flame height decreases after continuous firing.)

NOTICE: When use external gas bottle/cylinder, the flame height is closely related with gas tank pressure. The higher the pressure the higher flame height. The flame height can reach about 1.3m when pressure arrived 1MPa.

2. Battery for uFlamer Gasbar

uFlamer Gasbar can be powered through 8 pcs of 18650 cells. New Gasbar come only with battery compartment, customer need to get 18650 cells locally. The battery we suggest to use is PANASONIC 3400mAh NCR18650B with flat head as below:



The battery installations are as below:

a) Unscrew the screws of the battery box at the bottom panel as below.

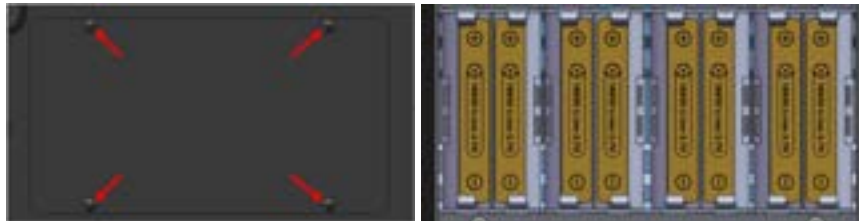

b) Install the battery in correct direction, pay attention to the positive and negative pole. Wrong installation will damage the battery box or even machine.

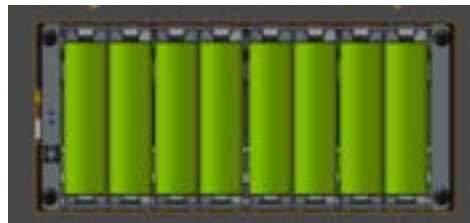

c) Press and hold the reset button (as show in the red circle below) for 1s to activate battery.

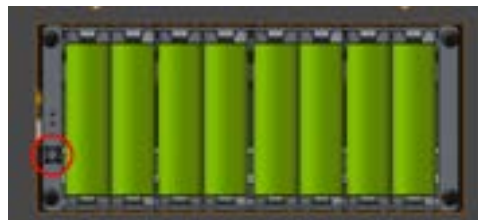

d) Install back the battery box plate.

e) Charging: charging automatically when machine connected with AC power supply (no matter machine was powered on or not)

NOTICE: To avoid the damage of battery, charge the battery at least once per month.

NOTICE: 18650 battery activation is necessary whenever install the battery.

3. Install uFlamer Gasbar

- a) For safety, uFlamer Gasbar can only be installed horizontally. Please install it on solid and stable surface.
- b) For truss installations always connect with safety rope to ensure extra safety. If there is any other national or regional guidelines please follow it accordingly.
- c) Double confirm the machine was firmly installed.

4. Install gas cartridges for Gasbar

- a) Before install gas cartridges please confirm safety switch stays at TEST MODE as below.



- b) Open the gas cartridge door, close the shut-off valves on cartridge holder. Rotate the knob clockwise to the end position to close the shut-off valve.



- c) Screw the gas cartridge to cartridge holder tightly. If use external gas cylinder please connect the gas hose quick coupler with machine quick coupler directly. Gas hose is optional part, you should prepare it yourself, if you need to order from us please contact your regional SHOWVEN sales for help.



WARNING: uFlamer Gasbar only support gasiform phase fuel. Liquid phase fuel is forbiddeng to use on uFlamer Gasbar.

WARNING: When use the gas cylinder, it is mandatory to use a pressure regulator and the maximum output pressure must not be higher than 15bar. The usage of gas bottles without pressure regulator is an extreme accident hazard and is strictly prohibited.

- d) Open the shut-off valve by rotate the knob anti-clockwise to the end position. Close the gas cartridge door.

5. Inset E-Stopper or E-stop terminator

The E-Stop interface is power cut-off interface, and the device can be powered on normally only after the interface is connected.

E-Stop terminator (standard configuration, SFMET1107).

Put the E-Stop terminal in the E-Stop IN interface.

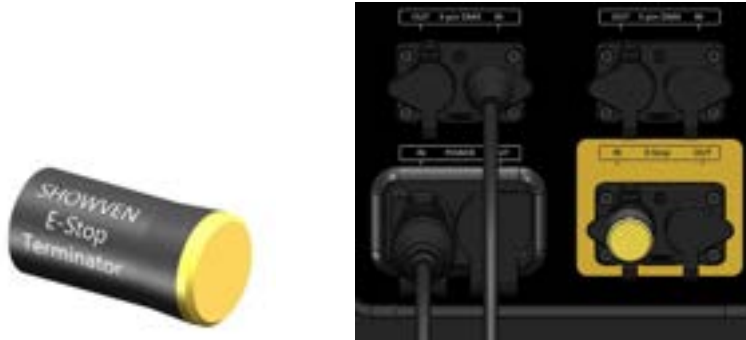

E-Stopper (optional, FPEST001).

E-Stopper can both connects with a single unit of uFlamer Gasbar or multi units (max.24) of Gasbar in daisy chain.



NOTICE: For more information about E-Stopper please check the E-Stopper manual.

6. Connecting uFlamer Gasbar

Make sure the DMX console is disarmed or powered off during cable connection.

- Connect a DMX cable to the DMX IN socket of first unit of uFlamer Gasbar, another head of this DMX cable connect to DMX console (such as FXcommander). Make sure the DMX console is powered off.
- Connect a DMX cable to the DMX OUT socket of previous uFlamer Gasbar, and the other end to the DMX IN of next machine. Connect all devices in series in this way.
- Suggest to plug in a DMX terminator into the DMX OUT in last unit of machine to improve signal reliability. For distance >200m please use SHOWVEN DMX splitter 8 to amplify the signal.
- Connect a power cable to the POWER IN socket of uFlamer Gasbar. Connect the other end of power cable to the power source. Make sure power supply is consistent with the rated voltage of the equipment, and the socket must well grounded. (if it is battery powered then no need to connect with power cable)

- e) Each unit of uFlamer Gasbar can be connected to power supply directly. If connect machine in sequence, please connect a power link cable to the POWER OUT of previous machine, connect the other end of the power link cable to POWER IN of the next machine. Do not connect exceed units to a single electrical circuit.
- f) Connect machine with E-stop terminal or E-Stopper.
- g) Power on all uFlamer Gasbar. Check the safety button, double confirm it stays at "TEST MODE" .



- h) Assign DMX address for each unit of uFlamer Gasbar. If use SHOWVEN host controller or FXcommander to control the machine please allocate a unique DMX address for each unit of machine.

7. Power ON the DMX console and programming

Power on DMX console and program the uFlamer Gasbar effect on DMX console

8. Test the ignition function of uFlamer Gasbar

Test the ignition function of uFlamer, we can check whether the igniters of each unit of uFlamer is working fine. Due to the safety switch is stay at TEST MODE there will be only ignition while jet solenoid valve is not open, so no flames generated.

9. Firing

- a) Double confirm the prescribed safety isolation zone is clear, no person, animal or other property within this region.
- b) Switch the safety key of uFlamer Gasbar to USER MODE.



- c) Firing, the operator should always have a clear view of the device, so that he/she can stop the show immediately when there is danger.

10. Power OFF and close the shut-off valve

- a) Power OFF DMX console
- b) Press E-Stopper to power OFF all machine
- c) Close the shut-off valve for each machine

11. Empty the remaining fuels and package machine

- a) Release the E-Stopper allow machine to be power on again, firing machine several times until no flame is being generated
- b) Switch safety switch of uFlamer Gasbar to TEST MODE
- c) Disassemble the gas cartridges
- d) Power OFF uFlamer Gasbar
- e) Unplug power cable, DMX cable, E-Stopper connection cable etc.
- f) Package the machine when it is cool down

WARNING: uFlamer Gasbar only support gasiform fuel, forbid to use liquid gas on it.

DANGER: Forbiden to pack, ship and storage uFlamer Gasbar with gas cartridges in it.

WARNING: Make sure there is no fuel remains in machine whenever pack, ship and store the device.

DANGER: There must be exhaust vent for flightcase or package box of uFlamer Gasbar.

NOTICE: When the device is placed or transported without packaging, please use adhesive tape to cover the nozzle to prevent foreign matter from entering.

▲ Maintenance

1. To maintain the machine in good performance and running status, it is recommended to running the device at least once per month.
2. Check the ignition probes both before and after each show, if there is any foreign objects on it please clean it up.
3. Shut-off valve maintenance: make sure there is no impurities in the gas cartridge. If the machine is not use for a long time, it is recommended to use tape to seal the cartridge holder connection part .
4. Maintenance of the nozzle: Nozzle needs to be cleaned from time to time, and it is recommended that once every six months (depending on the environment and frequency of use). In the process of using the equipment, if the flame shape is seriously deformed or the fuel injection line is significantly deformed or coarsened, the nozzle should be removed immediately for cleaning. If after clean, there are still problems please replace new nozzle.
5. Maintenance of the O-ring: If it is found that the O-ring of the nozzle is damaged or ageing when cleaning the nozzle, the O-ring should be replaced in time.

O ring 3: outer diameter 12mm X wire diameter 1.9mm



▲ Warranty Instructions

- \ Sincere thanks for your choosing our products, you will receive quality service from us
- \ The product warranty period is one year. If there are any quality problems within 7 days after shipping out from our factory, we can exchange a brand new same model machine for you
- \ We will offer free of charge maintenance service for machines which with hardware malfunction (except for the instrument damage caused by human factors) in warranty period. Please don't repair machine without factory permission

Below situations NOT included in warranty service:

- \ Damage caused by use unqualified aerosol, gas cartridges/bottles;
- \ Damage caused by improper transportation, usage, management, and maintenance, or damage caused by human factors;
- \ Disassemble, modify or repair products without permission;
- \ Damage caused by external reasons (lightning strike, power supply etc.)
- \ Damage caused by improper installation or use;

For product damage not included in warranty range, we can provide paid service.

Invoice is necessary when applying for maintenance service from SHOWVEN

SHOWVEN[®]



Showven Technologies Co., Ltd.

Tel: +86-731-83833068

Web: www.showven.cn E-mail: info@showven.cn

Add: No.1 Tengda Road, Liuyang Economic & Technical Development Zone, Changsha, Hunan, 410300,
P.R.China